

FORMAT



ALUMINIUM SYSTEME - 2024

FORMAT - Aluminum Systems

Individuelles Raumdesign
mit Aluminium



**QUADRO
DRIVE**

PROFIL | PROFILE:



AL1
NATUR MATT ELOXIERT
NATURAL MATT ANODISED

GLAS | GLASS:

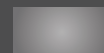

P7s
PARSOL GRAU
PARSOL GRAY



**QUADRO
FLY**

PROFIL | PROFILE:



AL1
NATUR MATT ELOXIERT
NATURAL MATT ANODISED

GLAS | GLASS:

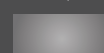

P7s
PARSOL GRAU
PARSOL GRAY

PLINTO
DRIVE

PROFIL | PROFILE:



AL1
NATUR MATT ELOXIERT
NATURAL MATT ANODISED

GLAS | GLASS:



LF
WEIß-DEKORPLATTE



WOOD
DRIVE

PROFIL | PROFILE:



AL1
NATUR MATT ELOXIERT

TÜRBLATT | DOOR LEAF:



LRG
DEKORPLATTE ROVERE GRIGIO
LAMINATE ROVERE GRIGIO

GRIFF | HANDLE:
SQARE 160



PLINTO
FLY

PROFIL | PROFILE:



EF
EDELSTAHL EFFEKT ELOXIERT
STAINLESS STEEL EFFECT ANODISED

GLAS | GLASS:



ML14
METALL BRONZE SATINIERT
METALL BRONZE SATINIERT



WOOD
FLY

PROFIL | PROFILE:



AL1
NATUR MATT ELOXIERT
NATURAL MATT ANODISED

TÜRBLATT | DOOR LEAF:



LNМ
DEKORPLATTE NOCE MILANO
LAMINATE NOCE MILANO

GRIFF | HANDLE:
SQARE 160



ALBATROS
FLY



PROFIL | PROFILE:



AL1
NATURMATT ELOXIERT
NATURAL MATT ANODISED

GLAS | GLASS:



E
KLAR
TRANSPARENT

GRIFF | HANDLE:
ALBATROS

ALBATROS
FLY



PROFIL | PROFILE:



AL1
NATURMATT ELOXIERT
NATURAL MATT ANODISED GLAS:

GLAS | GLASS:



OWE
KLAR SUPERCLEAR
TRANSPARENT SUPERCLEAR

GRIFF | HANDLE:
ALBATROS

PRODUCT MAP

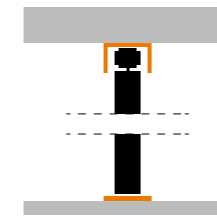

DRIVE

UNTEN GEFÜHRTE SCHIEBETÜREN
mit Decken- und Bodenschiene.

BOTTOM-RUNNING SLIDING DOORS
with ceiling and floor rail.

Mit Bodenschiene
With bottom track

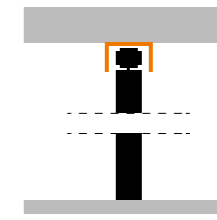



FLY

HÄNGESCHIEBETÜREN
ohne Bodenschiene.

HANGING SLIDING DOORS
without bottom track

Hängeschiebetüren
Top hung sliding doors

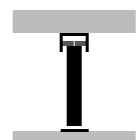
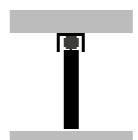
Tür Typ
Door Type

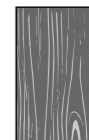
Tür Typ <i>Door Type</i>	SCHIEBETÜRSYSTEM SLIDING DOOR SYSTEM		FÜLLUNG TYP INLAY TYPE	
	DRIVE	FLY	GLAS	HOLZ
				
QUADRO	✓	✓	✓	✓
PLINTO	✓	✓	✓	✓
WOOD	✓	✓		✓
ALBATROS		✓	✓	

DRIVE

UNTEN GEFÜHRTE SCHIEBETÜREN mit Decken- und Bodenschiene.
 BOTTOM ROLLING SLIDING DOORS with upper and bottom tracks .

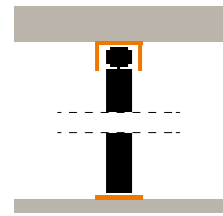

Mit Bodenschiene
with bottom track

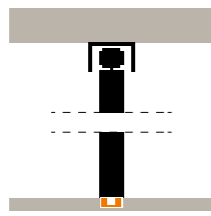

Optional: versenkte
Bodenschiene
Optional: flush
bottom track

Empfohlen für | Suggested for

Gardrobe | Wardrobe
eine Nische schliessen | Niche closing

QUADRO | PLINTO

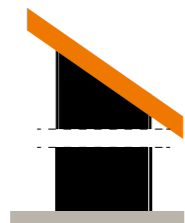

Auch für Dachschräge
möglich | Possible also
for roof slope

Verfügbare Füllungen | Available inlays

GLAS | GLASS HOLZ | WOOD

WOOD



Auch für Dachschräge
möglich | Possible also
for roof slope

Verfügbare Füllungen | Available inlays

GLAS | GLASS HOLZ | WOOD

FLY

HÄNGESCHIEBETÜREN ohne Bodenschiene.
 TOP HUNG SLIDING DOORS without bottom tracks.

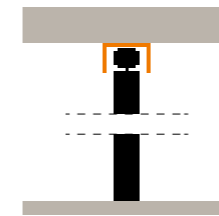

Hängeschiebetüren
Top hung sliding doors

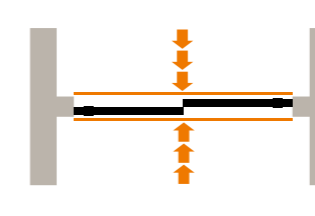

Empfohlen als Raumtrenner
Recommended as room divider

Empfohlen für | Suggested for

Raumtrennung | Room divider

QUADRO | PLINTO



Verfügbare Füllungen | Available inlays

GLAS | GLASS HOLZ | WOOD

WOOD



Verfügbare Füllungen | Available inlays

GLAS | GLASS HOLZ | WOOD

ALBATROS



Verfügbare Füllungen | Available inlays

GLAS | GLASS HOLZ | WOOD

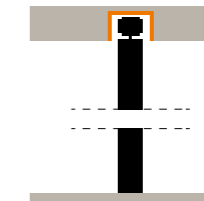

Optional: In die Decke
eingebaute Schiene
Optional: in the ceiling
mounted track

DRIVE

FLY

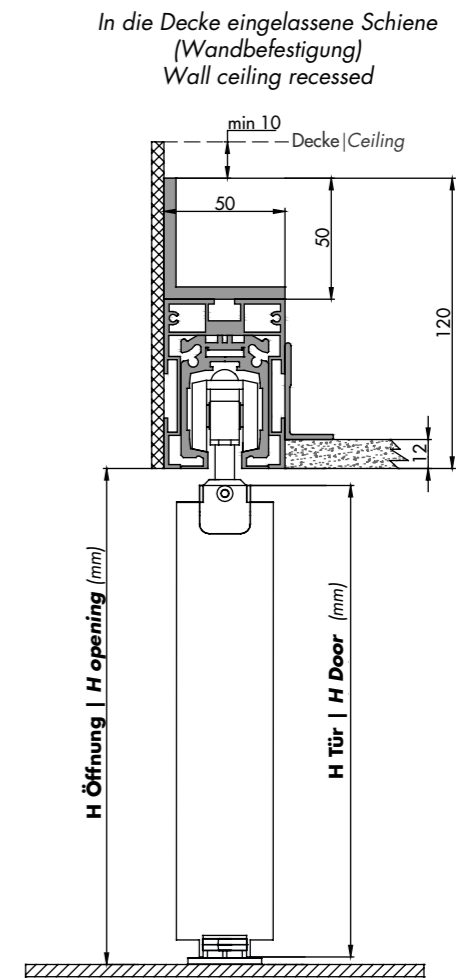
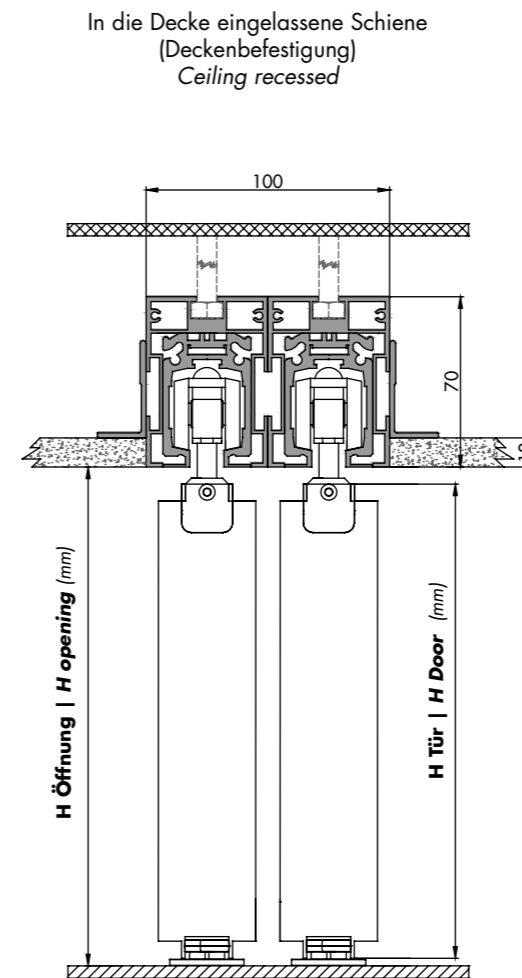
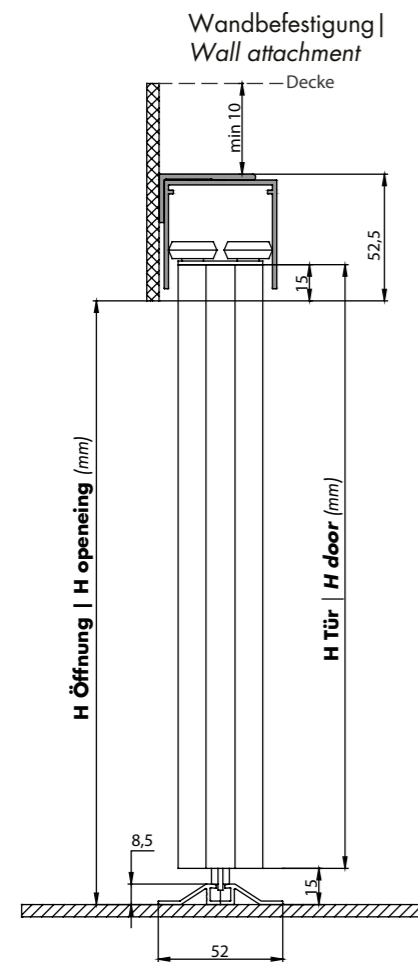
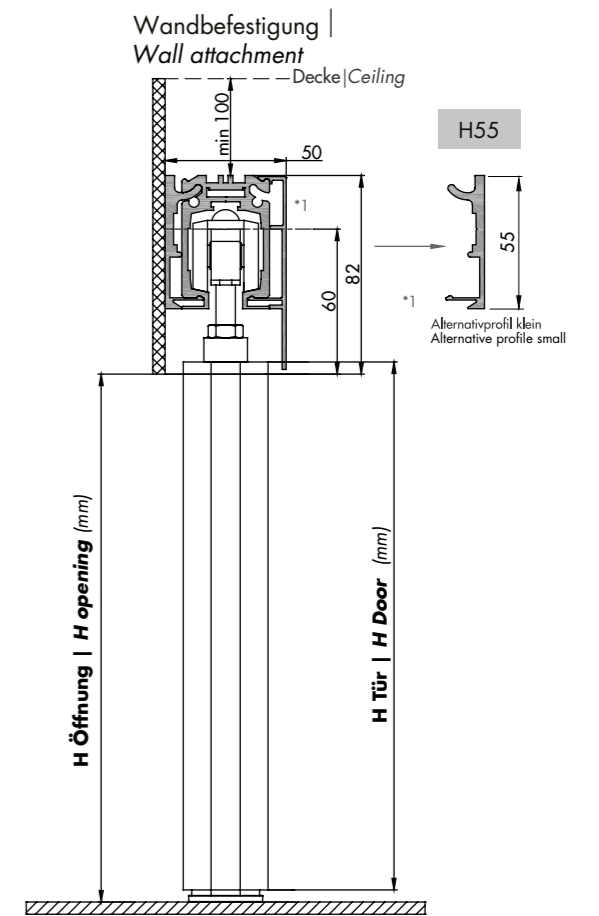
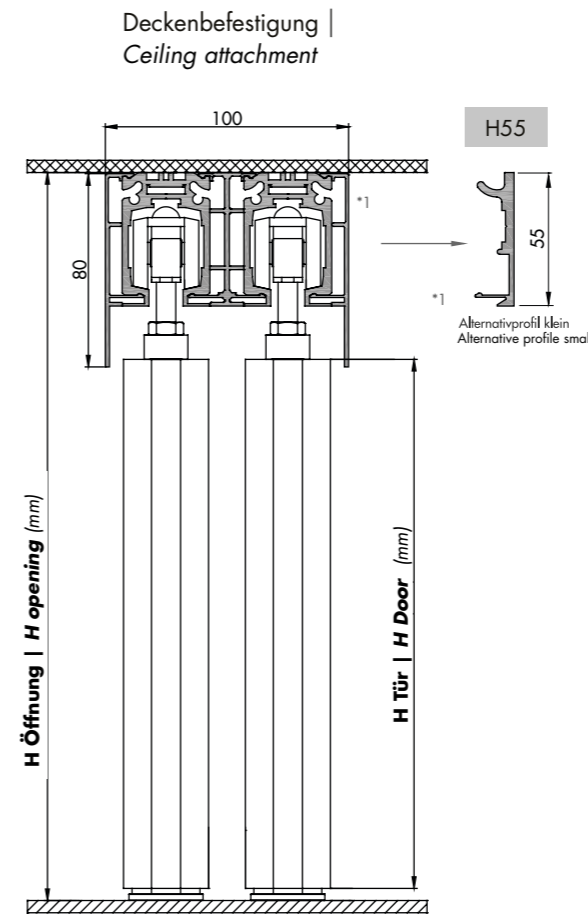
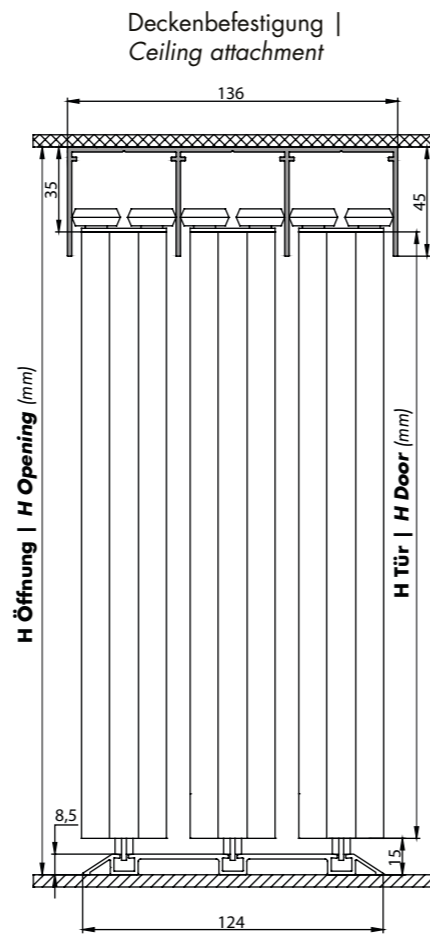
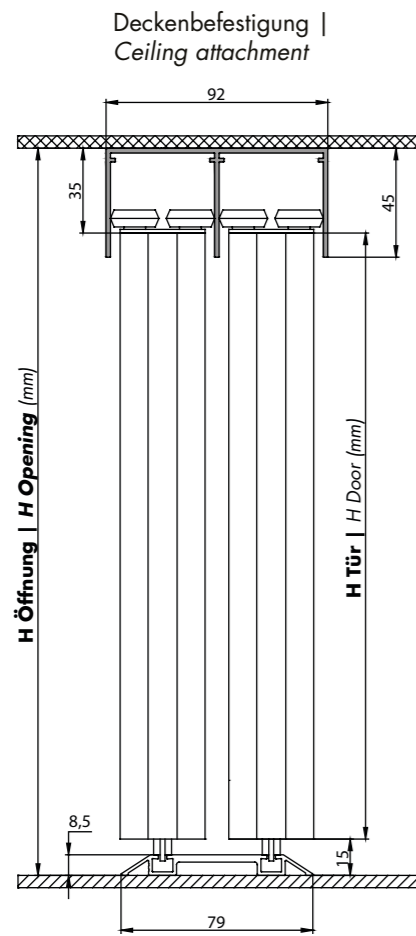

QUADRO

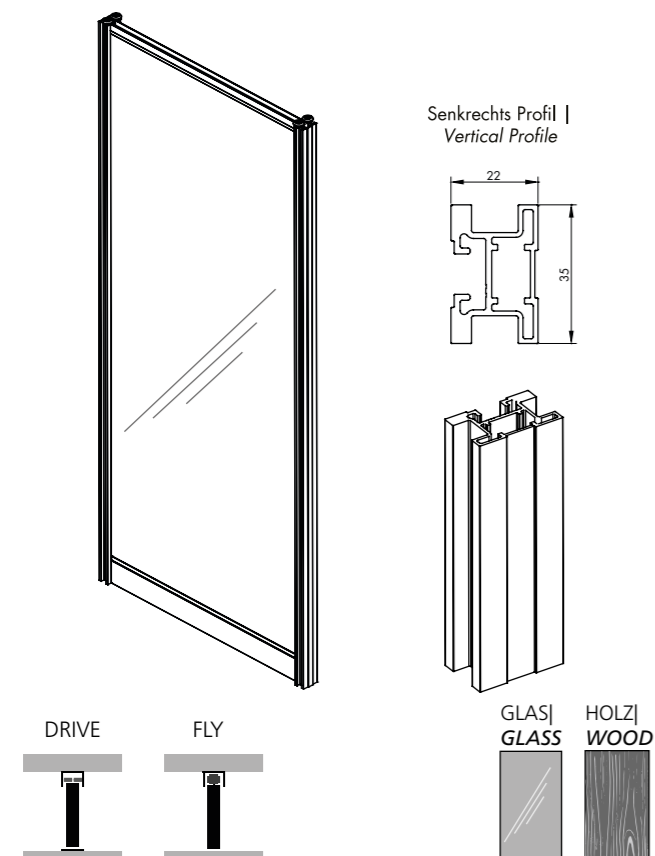

PLINTO

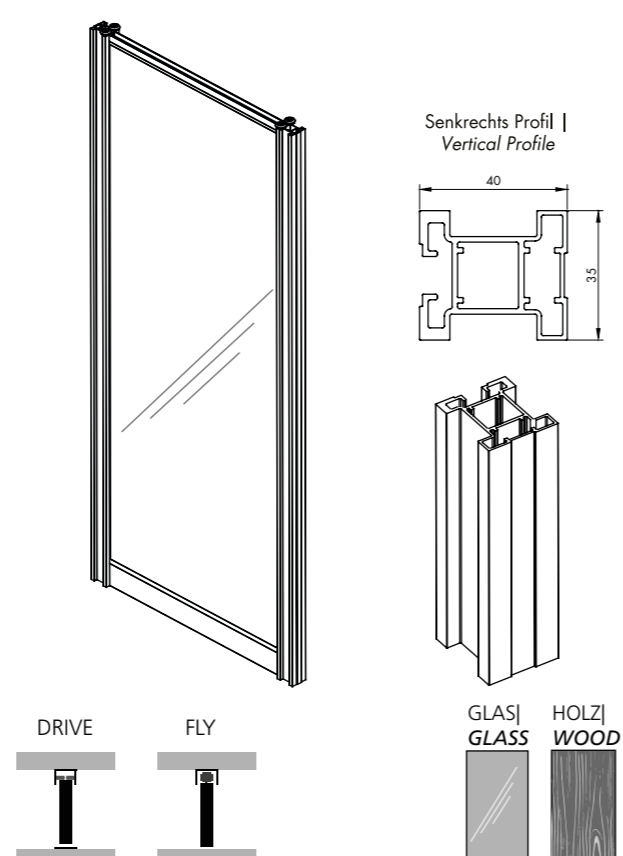

WOOD

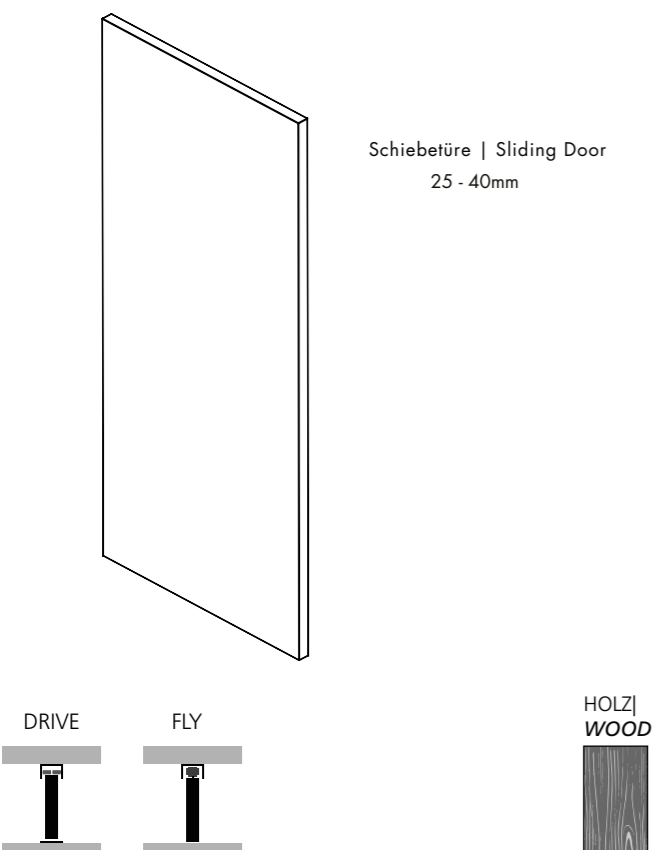

ALBATROS

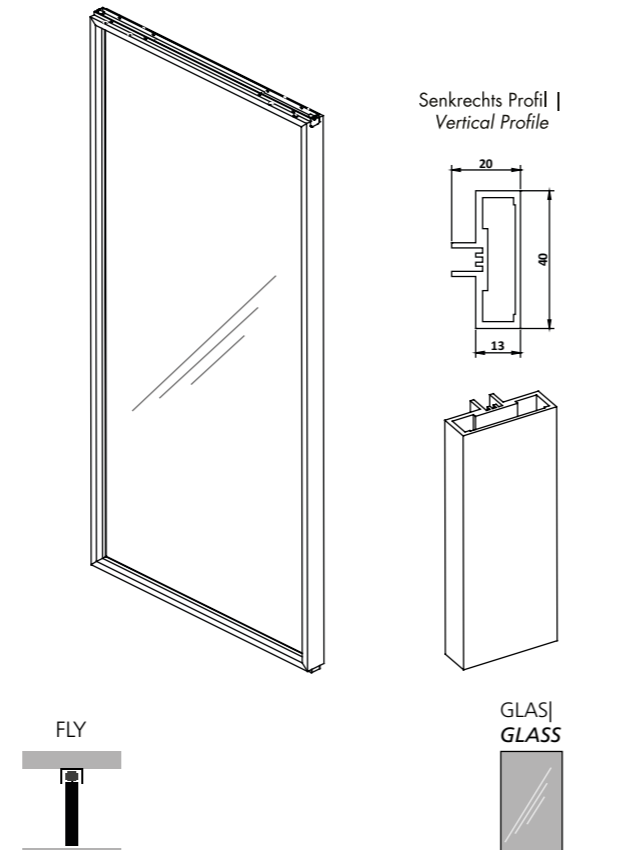

TRANSPARENTES GLAS
TRANSPARENT GLASS

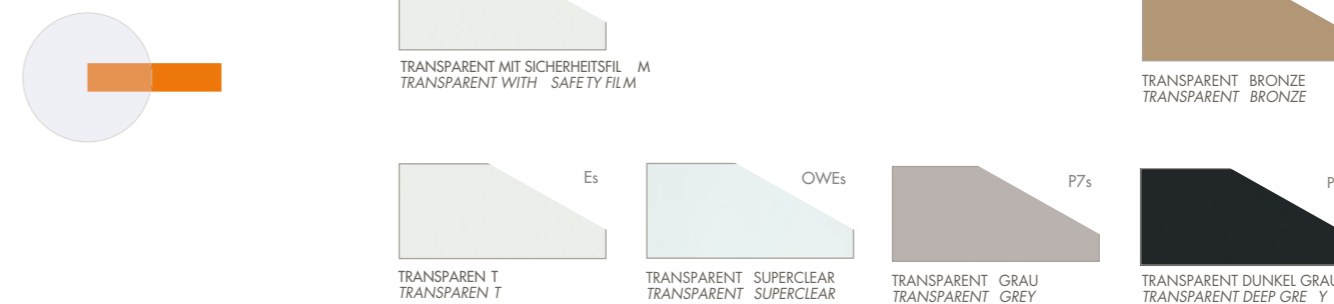

SATINIERTES GLAS
SATINATED GLASS

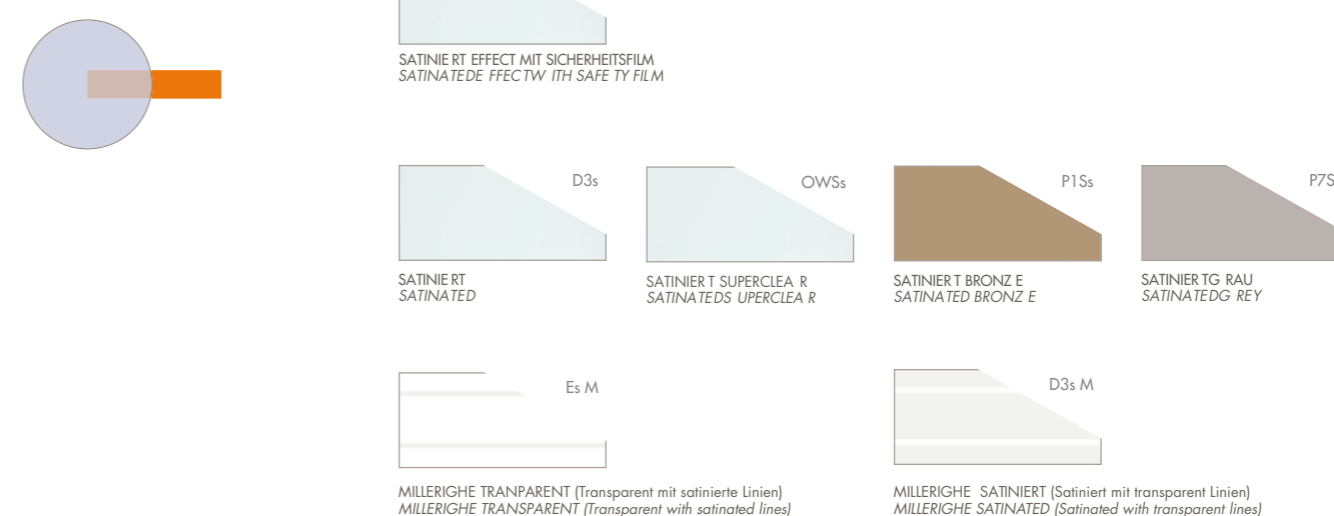

REFLEKTIERENDE
REFLEX (MIRROR-EFFECT)

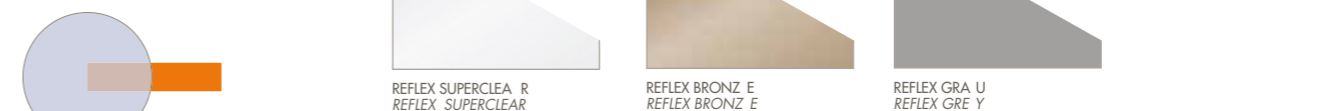

SPIEGEL
MIRRORS



Die auf dieser Seite angeführten Gläser sind gehärtet und entsprechen der Sicherheitsnorm EN 12150.
*Ausgenommen ist das Glas: VSG KLAR-VSG MATT-VSG BT, das mit 3+3 mm Sicherheitsfolie nach EN ISO 12543 laminiert ist.

The glass listed in this page are tempered and meet safety compliance EN 12150
* Exception the glass: VSG KLAR - VSG MATT - VSG BT which are 3+3 mm laminated with safety film in accordance to safety compliance EN ISO 12543

Bitte beachten Sie, dass die hier dargestellten Farben, leicht von den originalen Einlagen abweichen können.
Please be aware that colors here represented, could slightly diverge from real inlays colours.

FÜLLUNGEN | INLAYS

SPIEGEL MIRRORS

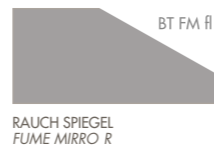
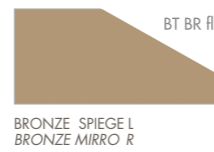
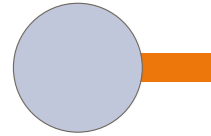

LACKIERTES GLAS GLÄNZEND * LAQUERED GLASS GLOSSY

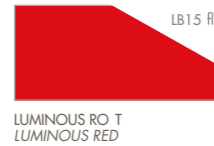
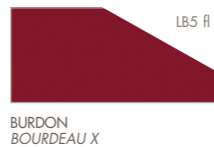
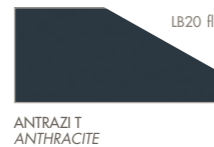
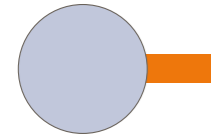

LACKIERTES GLAS SATINIERT * LAQUERED GLASS SATINATED

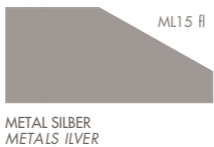
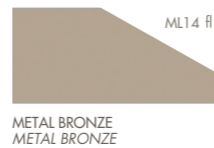
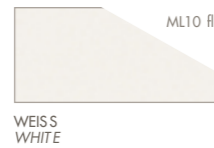
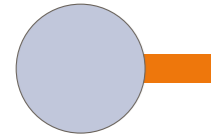

DOPPELSEITIGES GLAS DOUBLE GLASS

Die Türen können optional mit doppelseitigen Gläsern bestellt werden, um auf der Vorder- und Rückseite ein identisches Design zu haben. Die Duo-Version wurde speziell entwickelt, um die Vorder- und Rückseite mit Glas zu füllen - diese können auch von der Farbe unterschiedlich sein. (Keine transparenten Gläser - Klebestreifen)

The doors can optionally be ordered with double-sided glasses in order to have an identical design on the front and back. The duo version was specially developed to fill the front and back with glass - it can be also different in color. (No transparent glass - adhesive strips)

* Die lackierten Gläser und der Spiegel haben eine Sicherheitsfolie auf der Rückseite angebracht, welche auch ästhetische Irritationen (Bläschen) aufweisen kann. Die Sicherheitsfolie ist auf der Ansichtseite nicht sichtbar. Falls keine doppelseitigen Gläser gewählt werden, kann man diese auch mit einer weißen HDF Holzplatte (optional) auf der Rückseite bestellen.

* The backside of lacquered glass and mirrors inlays might have esthetical imperfections due to the safety film. In cases not chosen the DOUBLE GLASS option, white HDF (optional) back panel can be ordered.

* Die auf dieser Seite aufgeführten Gläser sind 4 mm dick mit Sicherheitsfolie nach DIN 12600 2B2
* The glass listed in this page are 4 mm thickness with safety film in accordance to DIN 12600 2B2

Bitte beachten Sie, dass die hier dargestellten Farben, leicht von den originalen Einlagen abweichen können.
Please be aware that colors here represented, could slightly diverge from real inlays colours.

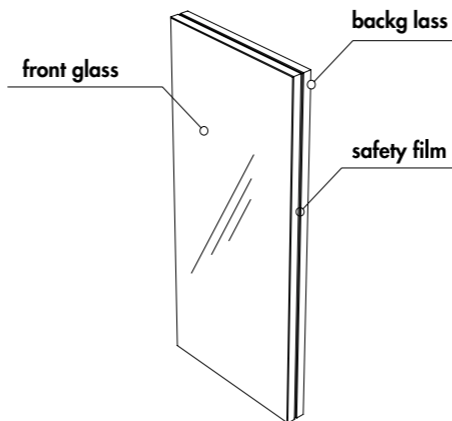

FÜLLUNGEN | INLAYS

HOLZ WOOD

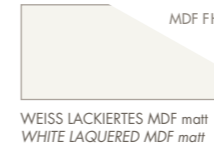

Die Einlagen werden standardmäßig mit vertikaler Faserrichtung geliefert. Die horizontale Faserrichtung ist optional auf Kundenwunsch möglich.
The inlays are supplied with a standard vertical grainline direction. Horizontal grainline direction is available upon request.

Bitte beachten Sie, dass die hier dargestellten Farben, leicht von den originalen Einlagen abweichen können.
Please be aware that colors here represented, could slightly diverge from real inlays colours.

HDF-Deckplatte für Rückseite der Füllungen | Inlay back side HDF cover panel



Profil Oberflächen | Profile finishes



AL1
NATUR MATT ELOXIERT
NATURAL MATT ANODISED



EF
EDELSTAHL EFFEKT (ELOXIERT)
STAINLESS STEEL EFFECT (ANODISED)



W
WEISS PULVERBESCHICHTET (RAL9003)
WHITE POWDER COATED (RAL9003)



AP
ANTHRAZIT PULVERBESCHICHTET (RAL7016)
ANTHRACITE POWDER COATED (RAL7016)





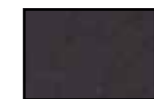





B
SCHWARZ PULVERBESCHICHTET (RAL9005)
BLACK POWDER COATED (RAL9005)







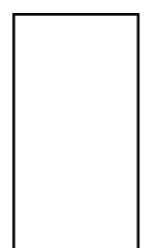

MB
METAL BRAUN PULVERBESCHICHTET
METAL BROWN POWDER COATED

BESTELLFORMULAR-SCHIEBETÜREN

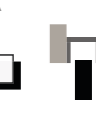
KUNDE		BESTELLNUMMER	
DATUM DER BESTELLUNG		GESPRÄCHSPARTNER	ANGEFORDERTES LIEFERDATUM
SYSTEM	TÜR		
DRIVE (Boden geführt)	<input type="checkbox"/> QUADRO	<input type="checkbox"/> PLINTO	<input type="checkbox"/> WOOD
FLY (Decken geführt)	<input type="checkbox"/> QUADRO	<input type="checkbox"/> PLINTO	<input type="checkbox"/> WOOD <input type="checkbox"/> ALBATROS
ÖFFNUNGS GRÖßEN	HÖHE (H Öffnung)(minimum) in mm: _____ BREITE (W Öffnung)(maximum) in mm: _____		
EINBAU	VERWEN- DEN	<input type="checkbox"/> SCHRANK- ODER NISCHENSCHLIEßUNG <input type="checkbox"/> RAUMTEILER <input type="checkbox"/> DURCHGANGSTÜR	
	FESTSET- ZUNG	<input type="checkbox"/> DECKE  <input type="checkbox"/> WAND  <input type="checkbox"/> IN DIE DECKE EINGELASSENE SCHIENE 	<input type="checkbox"/> ALBATROS - DUO - VARIA 
	EINLÄU- FIGE SCHIENE		
	ZWEILÄU- FIGE SCHIENE		
	DREILÄU- FIGE SCHIENE	 Zeichnen Sie eine andere Option <input type="checkbox"/> Senden Sie der Schiene vorab	
PROFILOBER- FLÄCHE	Code oder Beschreibung: _____		
DOOR PANEL	<input type="checkbox"/> Beidseitige lackiertes Glas (siehe Oberflächenseiten)  <input type="checkbox"/> Optionales HDF Deckplatte (siehe Oberflächenseiten)	Bitte markieren Sie die Positionen der Sprossen auf der Zeichnung. <input type="checkbox"/> HORIZONTAL Menge: _____ <input type="checkbox"/> VERTIKAL Menge: _____ 	Write in the drawing the code of the selected inlays
DÄMPFUNG	<input type="checkbox"/> ÖFFNEN	<input type="checkbox"/> SCHLIESSEN	<input type="checkbox"/> MITTE (*1) nur bei DRIVE Menge: _____ Produktcode: _____
GRIFFE	Code : _____ Menge : _____ * Geben Sie die Positionen in der Zeichnung von „EINBAU“ an.		
OPTIONALES ZUBEHÖR	WANDABSCHLUSSPROFIL	TYP DES ABDECKUNGSPROFILS (Duo - Albatros - Varia)	SCHLOSS (nur bei Plinto)
	<input type="checkbox"/> LINKE SEITE <input type="checkbox"/> RECHTE SEITE	<input type="checkbox"/> H 55 mm <input type="checkbox"/> H 80 mm	<input type="checkbox"/> JA <input type="checkbox"/> NEIN
NOTIZEN	UNTERE VERBINDUNGSFÜHRUNG (nur bei FLY) <input type="checkbox"/> JA <input type="checkbox"/> NEIN		

ORDER FORM-SLIDING DOORS

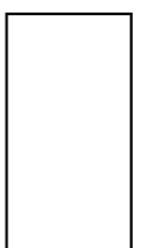
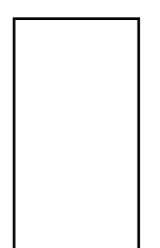
CUSTOMER		ORDER REFERENCE	
DATE OF THE ORDER		CONTACT PERSON	REQUESTED DELIVERY DATE
SYSTEM	DOOR		
DRIVE (bottom rolling)	<input type="checkbox"/> QUADRO	<input type="checkbox"/> PLINTO	<input type="checkbox"/> WOOD
FLY (suspended)	<input type="checkbox"/> QUADRO	<input type="checkbox"/> PLINTO	<input type="checkbox"/> WOOD <input type="checkbox"/> ALBATROS
OPENING SIZES	HEIGHT (H opening)(minimum) in mm: _____ WIDTH (W opening)(maximum) in mm: _____		
INSTALLATION	USE	<input type="checkbox"/> CLOSET OR NICHE CLOSING <input type="checkbox"/> ROOM DIVIDER <input type="checkbox"/> PASSAGE DOOR	
	FIXING	<input type="checkbox"/> CEILING  <input type="checkbox"/> WALL  <input type="checkbox"/> RECESSED TRACK 	<input type="checkbox"/> ALBATROS - DUO - ATLANTIC - VARIA 
	SINGLE TRACK		
	DOUBLE TRACK		
	TRIPLE TRACK	 draw different option <input type="checkbox"/> Send the track separately	
PROFILES FINISH	Code or description: _____		
DOOR PANEL	<input type="checkbox"/> Double-sided lacquered glass (see finishes pages)  <input type="checkbox"/> Optional HDF panel (see finishes pages)	Please indicate the positions of the dividers on the drawing. <input type="checkbox"/> HORIZONTAL Quantity: _____ <input type="checkbox"/> VERTICAL Quantity: _____ 	Write in the drawing the code of the selected inlays
SPEED REDUCER	<input type="checkbox"/> OPENING	<input type="checkbox"/> CLOSING	<input type="checkbox"/> CENTER (*1) only DRIVE Item code: _____ Quantity: _____
HANDLES	Code : _____ Quantity : _____ * indicate the positions in the drawing of „Installation“.		
OPTIONAL ACCESSORIES	STRIKE PROFILE	TYP OF COVER PROFILE (Albatros - Atlantic - Varia)	LOCK (only Plinto)
	<input type="checkbox"/> LEFT SIDE <input type="checkbox"/> RIGHT SIDE	<input type="checkbox"/> H 55 mm <input type="checkbox"/> H 80 mm	<input type="checkbox"/> YES <input type="checkbox"/> NO
NOTES	DRAG DEVICE (only FLY) <input type="checkbox"/> YES <input type="checkbox"/> NO		



PROFIL | PROFILE

SAS 001



A
ANTRAZIT MATT ELOXIERT
| ANTRACITE MATT ANODISED

FÜLLUNG | INLAY

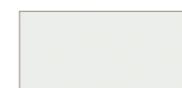

E
TRANSPARENT
| TRANSPARENT



PROFIL | PROFILE

SAS 077



AL1
NATUR MATT ELOXIERT
| NATURAL MATT ANODISED

FÜLLUNG | INLAY

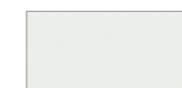

E
TRANSPARENT
| TRANSPARENT



PROFIL | PROFILE

SAS 999

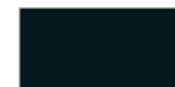

C35
SCHWARZ MATT ELOXIERT
| BLACK MATT ANODISED

FÜLLUNG | INLAY

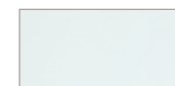

D3
SATINIERT
| SATINATED

PROFILOBERFLÄHEN | PROFILE FINISHES

		AL1	EA	W	A	C35	C2	MB
SCHMALE PROFILE NARROW PROFILES	SAS 001	✓	✓	✓	✓	✓		
	SAS 999	✓				✓		✓
BREITE PROFILE WIDE PROFILES	SAS 006	✓	✓				✓	
	SAS 077	✓	✓	✓	✓	✓		
	SAS 878	✓	✓	✓	✓	✓		
	SAS 067	✓	✓					
SPEZIELLE PROFILE SPECIAL PROFILES	SAS 6113B	✓	✓	✓	✓	✓		✓

AL1
NATUR MATT ELOXIERT
NATURAL MATT ANODIZED

EA
EDELSTAHEFFEKT ELOXIERT
STAINLESS STEEL EFFECT ANODIZED

W
WEISS PULVERBESCHICHTET MATT - RAL9003
WHITE POWDER COATED MATT - RAL9003

A
ANTRAZIT MATT ELOXIERT
ANTRACITE MATT ANODISED

C35
SCHWARZ MATT ELOXIERT
BLACK MATT ANODISED

C2
GOLD MATT ELOXIERT
GOLD MATT ANODISED

MB
METAL BRAUN PULVERBESCHICHTET MATT
METAL BROWN POWDER COATED MATT

FÜLLUNGEN | INLAYS

TRANSPARENTES GLAS *1
TRANSPARENT GLASS

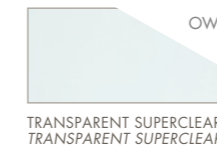
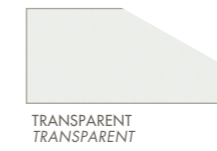
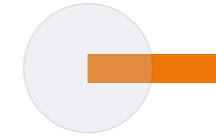

SATINIERTES GLAS *1
SATINATED GLASS

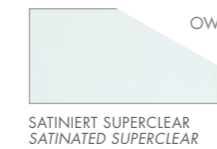
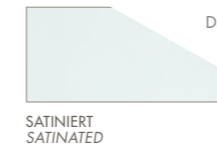
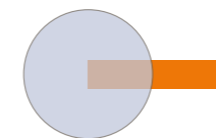

REFLEKTIERENDE *1
REFLEX (MIRROR-EFFECT)

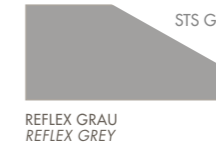
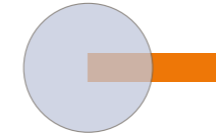

SPIEGEL *2
MIRROR

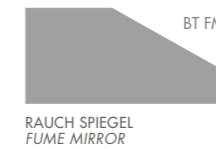
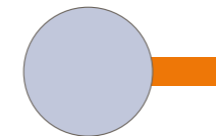

LACKIERTES GLAS GLÄNZEND *2
LAQUERED GLASS GLOSSY

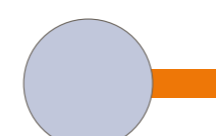

LACKIERTES GLAS SATINIERT *2
LAQUERED GLASS SATINATED

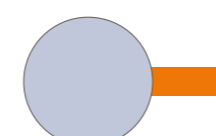

1. Dieses Glas kann gehärtet bestellt werden - These glasses can be ordered tempered
2. Diese Gläser können mit Sicherheitsfolie bestellt werden - These glasses can be ordered with safety film

SCHMALE PROFILE | NARROW PROFILES

SAS 001

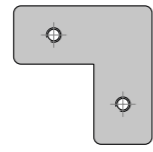
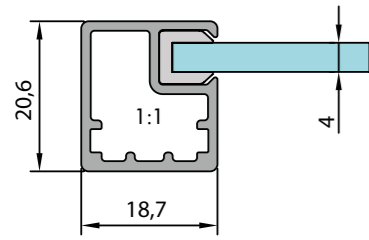

SAS E001



SAS G1/3V

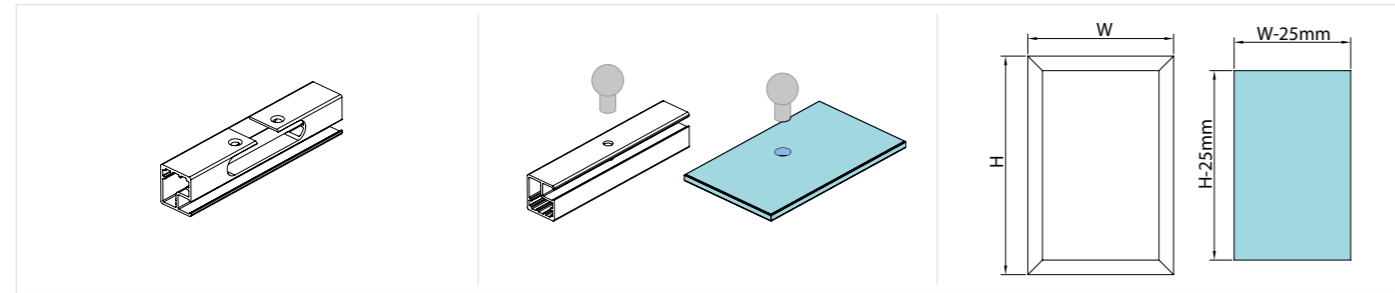

SAS 999

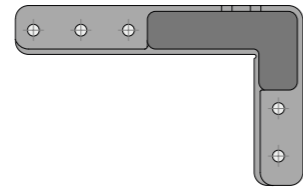
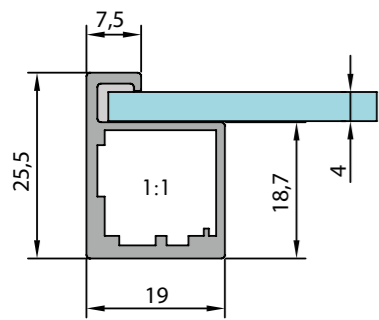

SAS E999



SAS VOG02G

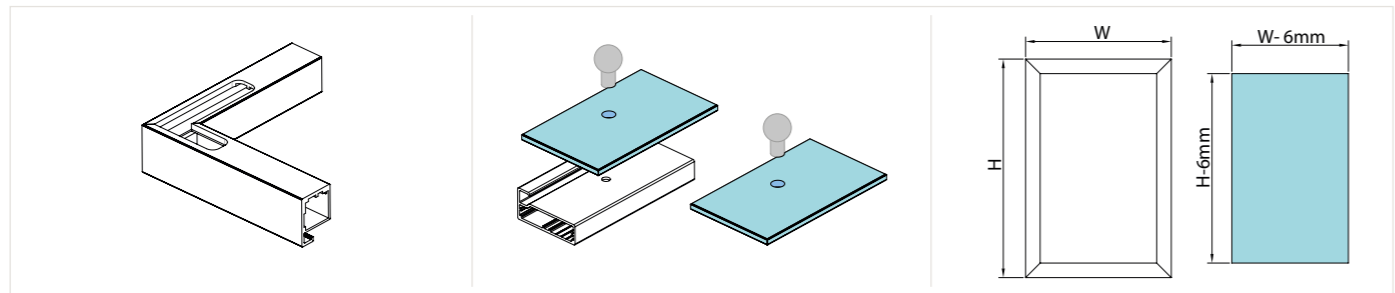

BREITE PROFILE | WIDE PROFILES

SAS 006

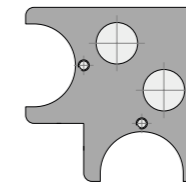
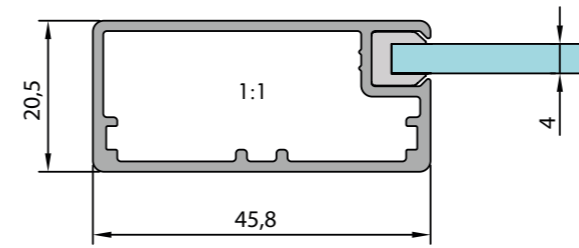

SAS E003



SAS G1/3

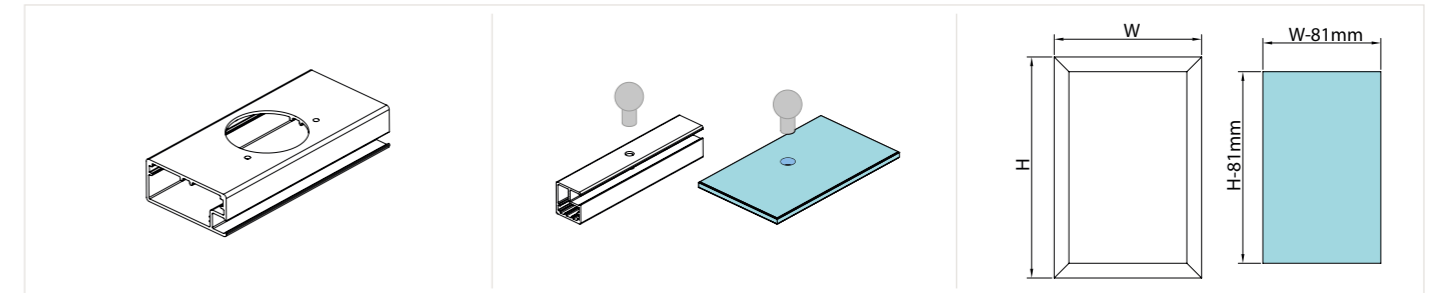

SAS 077

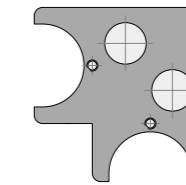
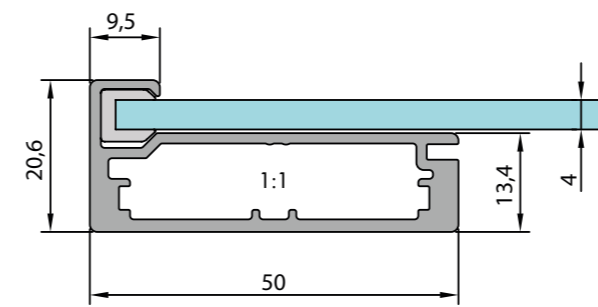

SAS E003



SAS G077



SAS G1/3

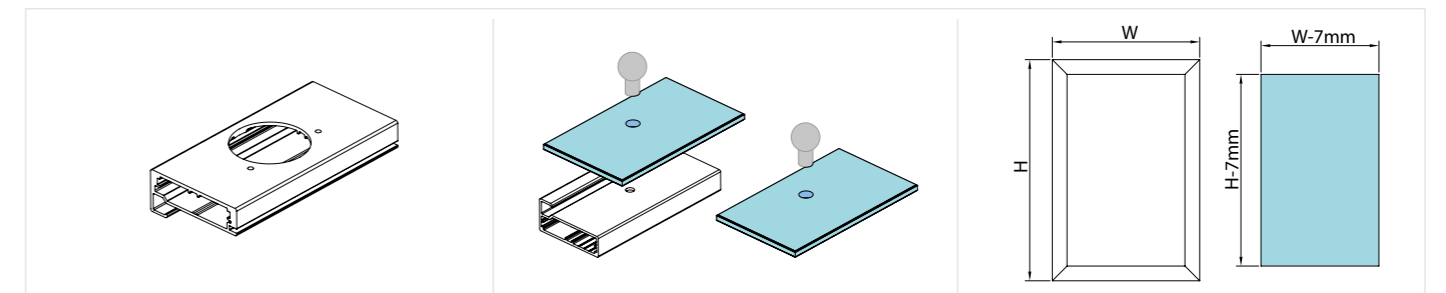

BREITE PROFILE | WIDE PROFILES

SAS 878

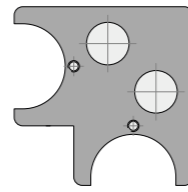
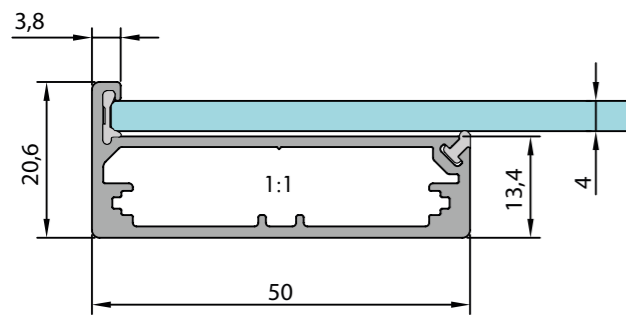

SAS E003



SAS G877



SAS G878



GRIFFPROFILE | HANDLE PROFILES

SAS 6113B

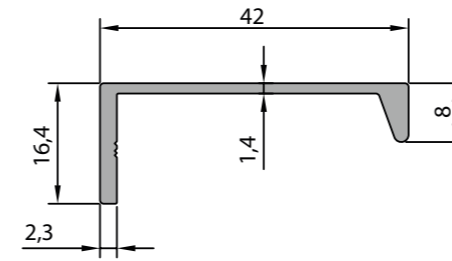

VERFÜGBAR FÜR | AVAILABLE FOR

- SAS 001
- SAS 006
- SAS 077
- SAS 878

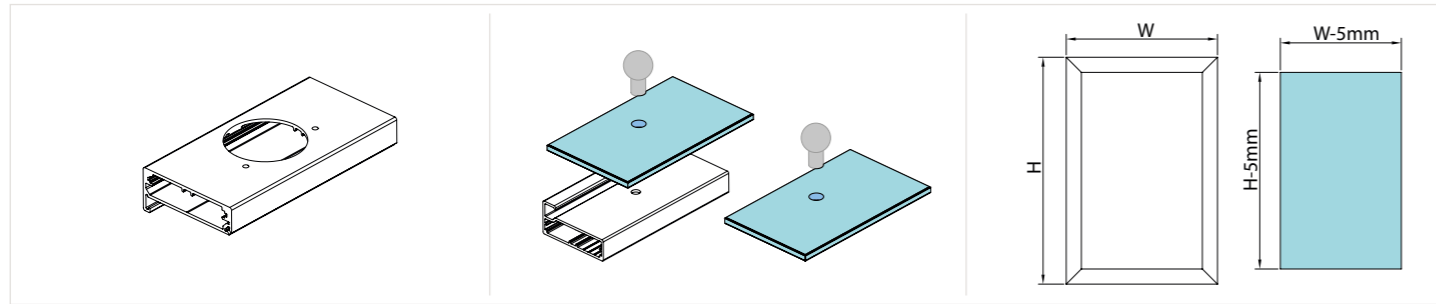

SAS 067

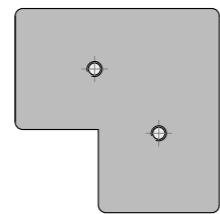
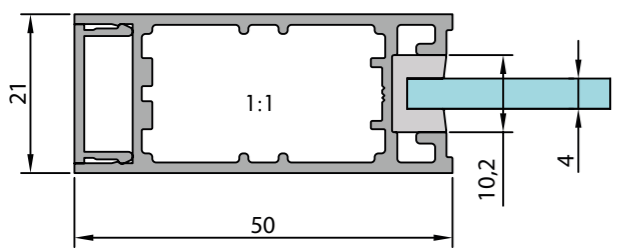

SAS E002



SAS 10/4



6 mm 8 mm 10 mm

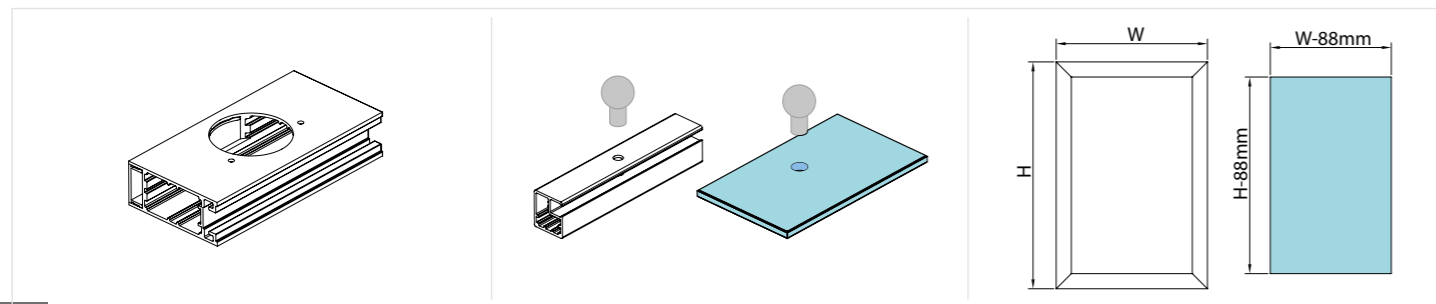
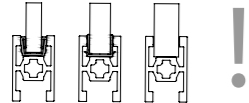

TECHNISCHE SPEZIFIKATION | TECHNICAL SPECIFICATION

STANDARD-SCHARNIERTYPEN - STANDARD HINGE TYPES

SCHMAL
NARROW

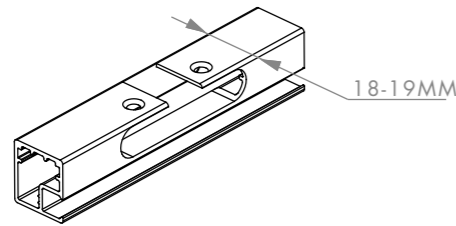

ANZAHL DER SCHARNIERE
NUMBER OF HINGES

H mm	STK - PC
350-900	2
901-1500	3
1501-2000	4

BREIT
WIDE

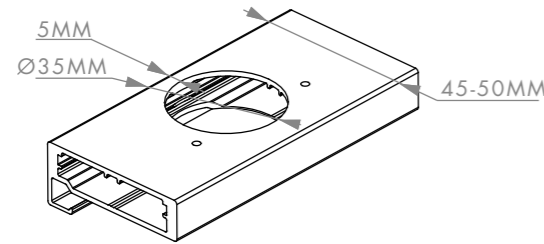

H mm	STK - PC
350-900	2
901-1500	3
1501-2000	4
2001-2400	5

STANDARD-SCHARNIERPOSITION - STANDARD HINGE POSITION

DREHTÜR
HINGED DOORS

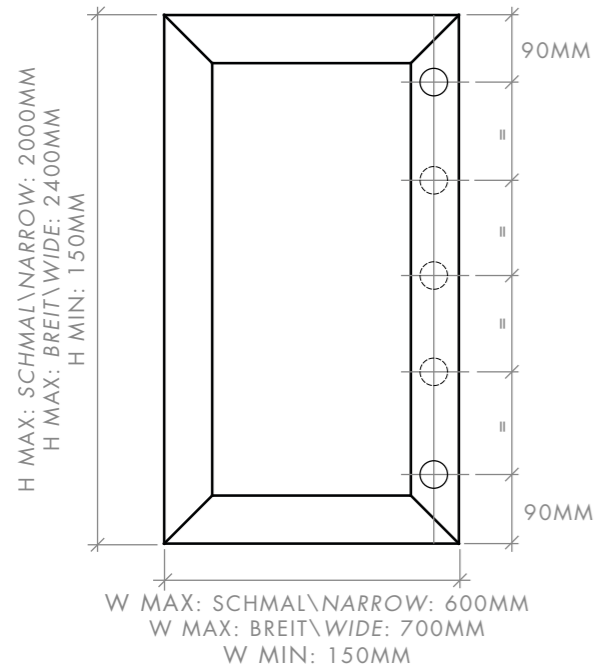

KLAPPTÜR
FLAP DOORS

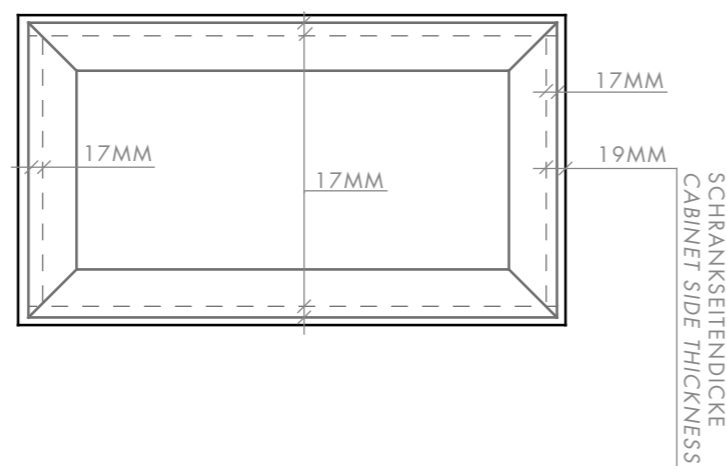

ANDERE NACH ANFRAGE
OTHERS BY REQUEST

GRIFFOHRUNGEN - HANDLE HOLES

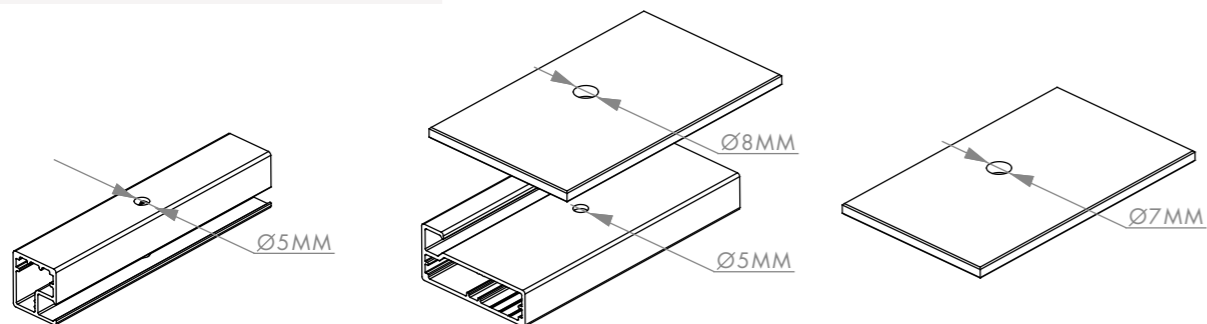

NUR AN DEN PROFIL
ONLY ON PROFILE

PROFIL UND GLAS
PROFILE AND GLASS

NUR AN DEN GLAS
ONLY ON GLASS

FIRMA\KUNDE CUSTOMER		KOMMISSION ORDER REFERENCE
DATUM DER BESTELLUNG DATE OF THE ORDER	GESPRÄCHSPARTNER CONTACT PERSON	GEWÜNSCHTER LIEFERTERMIN REQUESTED DELIVERY DATE

TÜR-TYP DOOR TYPE	<input type="checkbox"/> DREHTÜR HINGED	<input type="checkbox"/> KLAPPTÜR FLAP	<input type="checkbox"/> SCHIEBETÜR SLIDING
PROFIL PROFILE	TYP NB. TYPE NR.	OBERFLÄCHE SURFACE	
SCHARNIERFRÄSUNG HINGE MILLINGS	MARKE BRAND	HERSTELLER CODE MANUFACTURER CODE	

*WENN NICHT UNTERSCHIEDLICH ANGEGEBEN, WERDEN DIE SCHARNIERE VERTIKAL POSITIONIERT NACH ALUSTYLE STANDARD
*IF NOT DIFFERENTLY SPECIFIED, THE HINGES WILL BE POSITIONED VERTICALLY ACCORDINGLY TO ALUSTYLE STANDARD

*** BITTE BEACHTEN SIE, DASS ALLE ZEICHNUNGEN VORNGESICHT ZEIGEN. BITTE ANGABEN: GRÖSSE, SCHARNIERPOSITION, GRIFFPOSITION, FÜLLUNG CODE**
*** PLEASE NOTE THAT DRAWINGS ARE DOOR'S FRONT VIEW. PLEASE SPECIFY: SIZE, HINGE POSITION, HANDLE POSITION, INLAY TYPE**

* BITTE BEACHTEN SIE, DASS ALLE ZEICHNUNGEN VORNGESICHT ZEIGEN. BITTE ANGABEN: GRÖSSE, SCHARNIERPOSITION, GRIFFPOSITION, FÜLLUNG CODE * PLEASE NOTE THAT DRAWINGS ARE DOOR'S FRONT VIEW. PLEASE SPECIFY: SIZE, HINGE POSITION, HANDLE POSITION, INLAY TYPE	POS 1. *	W (MM) H (MM) FÜLLUNG CODE INLAY CODE MENGE\QUANTITYSTK\PC	POS 2. *	W (MM) H (MM) FÜLLUNG CODE INLAY CODE MENGE\QUANTITYSTK\PC
	POS 3. *	W (MM) H (MM) FÜLLUNG CODE INLAY CODE MENGE\QUANTITYSTK\PC	POS 4. *	W (MM) H (MM) FÜLLUNG CODE INLAY CODE MENGE\QUANTITYSTK\PC
	GRIFFE HANDLE	CODE		
	BITTE GEBEN SIE IN DEN OBIGEN ZEICHNUNGEN DIE GRIFFPOSITION AN, ODER SENDEN SIE EINE DETAILIERTE SKIZZE DARÜBER. PLEASE INDICATE ON THE ABOVE DRAWINGS THE HANDLE POSITION OR PLEASE SEND A DETAILED SKETCH ABOUT.			

NOTIZEN NOTES	
------------------	--



AL1

NATUR MATT ELOXIERT
NATURAL MATT ANODISED



AL1
NATUR MATT ELOXIERT
NATURAL MATT ANODISED

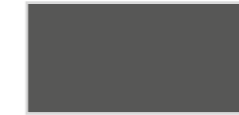

A
ANTHRAZIT MATT ELOXIERT
ANTHRACITE MATT ANODISED

GP SYSTEM

SÄULE UND BESCHLÄGE
UPRIGHTS AND FITTINGS

PROFILE / PROFIL

GP3

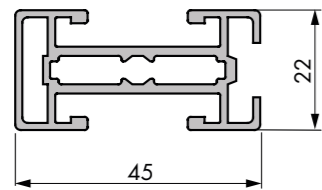

AL1
NATUR MATT ELOXIERT
NATURAL MATT ANODISED

W
WEISS PULVERBESCHICHTET MATT
WHITE POWDERCOATED MATT

A
ANTHRACIT MATT ELOXIERT
ANTHRACITE MATT ANODISED

SÄULENBESTIGUNG ZUR DECKE
MOUNT UPRIGHTS TO THE CEILING

SÄULENBESTIGUNG ZUR WAND
MOUNT UPRIGHTS TO THE WALL

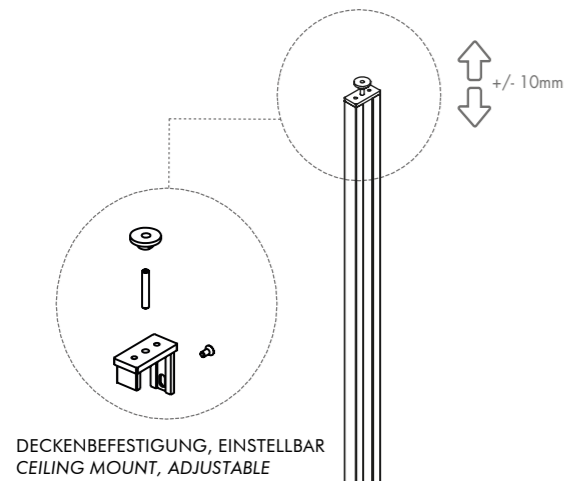

DECKENBESTIGUNG, EINSTELLBAR
CEILING MOUNT, ADJUSTABLE

VERSTELLBARER FUSS
ADJUSTABLE FOOT

OPTIONAL: ZUSÄTZLICHES PROFIL
OPTIONAL: ADDITIONAL PROFILE

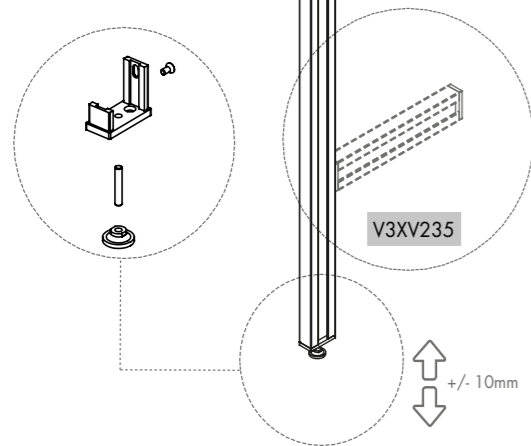

V3XV235

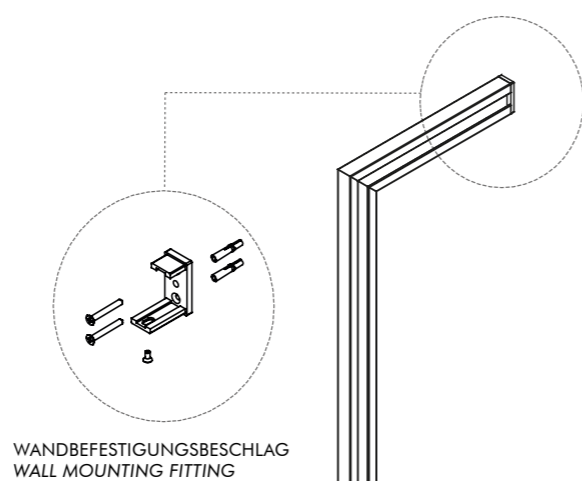

WANDBESTIGUNGSBESCHLAG
WALL MOUNTING FITTING

VERSTELLBARER FUSS
ADJUSTABLE FOOT

OPTIONAL: ZUSÄTZLICHES PROFIL
OPTIONAL: ADDITIONAL PROFILE

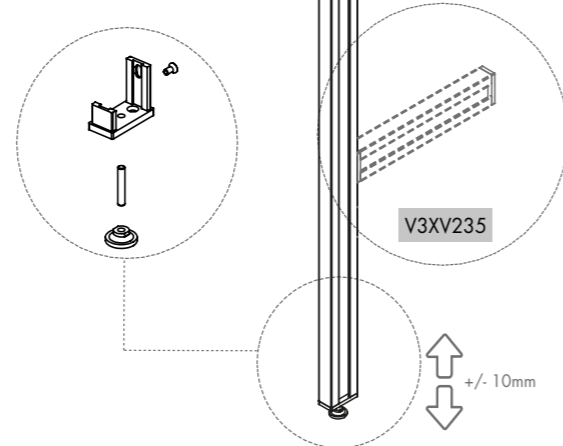

V3XV235

GP SYSTEM

SÄULE UND BESCHLÄGE
UPRIGHTS AND FITTINGS

EINBAUBEISPIEL | INSTALLATION EXAMPLE

BEFESTIGUNG ZUR WAND
WALL MOUNTING

BEFESTIGUNG ZUR DECKE
CEILING MOUNTING

DACHSCRAGE BEFESTIGUNG
SLANTED WALL MOUNTING

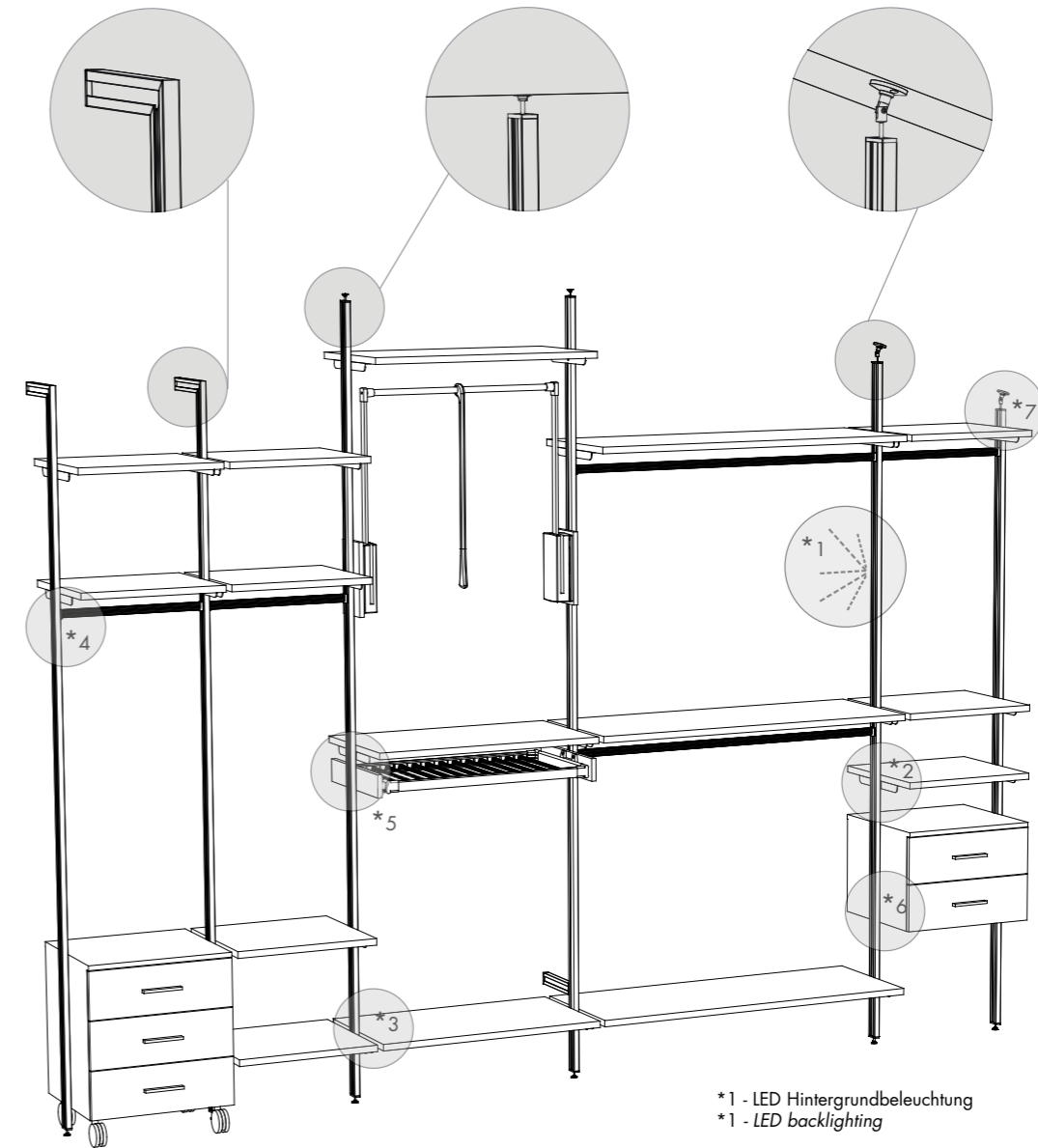

*1 - LED Hintergrundbeleuchtung
*1 - LED backlighting

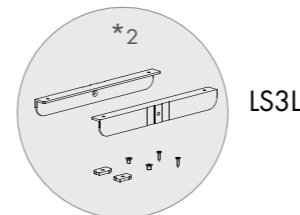

LS3L

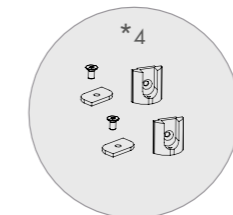

LSKS - GL22

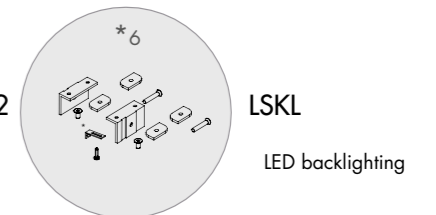

LSKL

LED backlighting

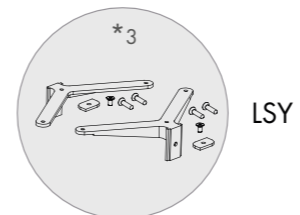

LSY

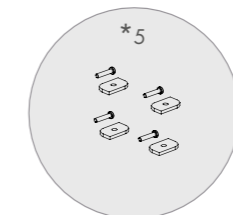

LSS

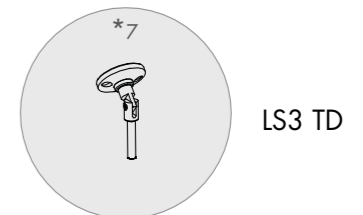

LS3 TD



"STRIPE"
LED MIRROR
SPIEGEL | MIRROR

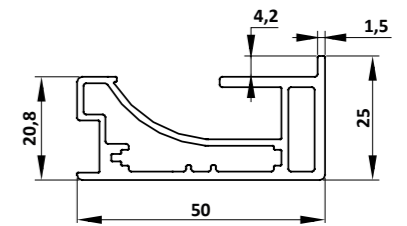

Kalt und warm einstellbares Licht
Cold and warm adjustable light

FERNBEDIENUNG
REMOTE CONTROL

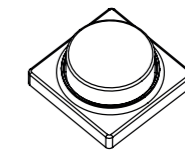

Der Spiegel kann auf Wunsch
auch in abgeschrägter Ausführung
gefertigt werden.

*The mirror can be, up on
request, manufactured also
with slanted design.*

PROFIL | PROFILE:



AL1
NATURMATT ELOXIERT
NATURAL MATT ANODISED

GLAS | GLASS:



BT
CLASSIC SPIEGEL
CLASSIC MIRROR

"STRIPE"
LED MIRROR
SPIEGEL | MIRROR

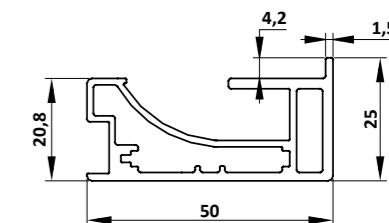

Kalt und warm einstellbares Licht
Cold and warm adjustable light

FERNBEDIENUNG
REMOTE CONTROL

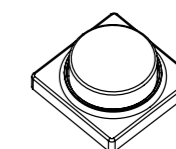

Der Spiegel kann auf Wunsch
auch in abgeschrägter Ausführung
gefertigt werden.

*The mirror can be, up on
request, manufactured also
with slanted design.*

PROFIL | PROFILE:



AL1
NATUR MATT ELOXIERT
NATURAL MATT ANODISED

GLAS | GLASS:



BT
CLASSIC SPIEGEL
CLASSIC MIRROR



"LUMIN"
ROUND LED MIRROR
SPIEGEL | MIRROR

LED Licht | LED light

- 4000K
- 3000K

OPTIONALE FERNBEDIENUNG
OPTIONAL REMOTE CONTROL

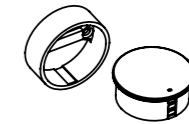

SPIEGELOPTIONEN |
MIRROR OPTIONS:



BT
CLASSIC SPIEGEL
CLASSIC MIRROR



BT BR
BRONZE SPIEGEL
BRONZE MIRROR

GLAS | GLASS:



BT
CLASSIC SPIEGEL
CLASSIC MIRROR



"LUMIN"
SQUARE LED MIRROR
SPIEGEL | MIRROR

LED Licht | *LED light*

- 4000K
- 3000K

OPTIONALE FERNBEDIENUNG
OPTIONAL REMOTE CONTROL

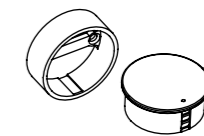

SPIEGELOPTIONEN |
MIRROR OPTIONS:



BT
CLASSIC SPIEGEL
CLASSIC MIRROR



BT BR
BRONZE SPIEGEL
BRONZE MIRROR

GLAS | *GLASS:*



BT
CLASSIC SPIEGEL
CLASSIC MIRROR

MUSTER KOFFER | SAMPLE SUITCASE

MST11



Der Musterkoffer enthält die meisten wichtigeren Profile und Oberflächen unseres SCHIEBETÜRSYSTEMS. Aus technischen Gründen und aufgrund individueller Anforderungen kann sich der Inhalt des Koffers geringfügig von dem hier auf den Bildern gezeigten ändern.

The samples suitcase contains most of the more significant profiles and finish of our SLIDING DOORS SYSTEM. Due to technical reason and customized needs, the content of the suitcase might slightly change from the one showed here in the pictures. piece.

MST03

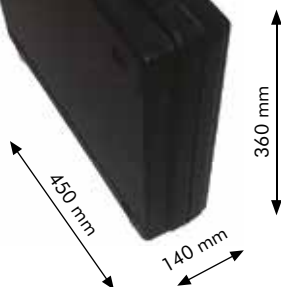

Der Musterkoffer enthält die meisten wichtigeren Profile und Oberflächen unseres GP SYSTEMS. Aus technischen Gründen und aufgrund individueller Anforderungen kann sich der Inhalt des Koffers geringfügig von dem hier auf den Bildern gezeigten ändern.

The samples suitcase contains most of the more significant profiles and finish of our GP SYSTEM. Due to technical reason and customized needs, the content of the suitcase might slightly change from the one showed here in the pictures.

